

2x150A Dual Channel Forward/Reverse Brushed DC Motor Controller



Roboteq's VDC2450 controller is designed to convert commands received from a RC radio, Analog Joystick, wireless modem, or microcomputer into high voltage and high current output for driving one or two DC motors. Designed for maximal ease-of-use, it is delivered with all necessary cables and hardware and is ready to use in minutes.

The controller's two channels can either be operated independently or mixed to set the direction and rotation of a vehicle by coordinating the motion on each side of the vehicle. The motors may be operated in open or closed loop speed mode. Using low-cost position sensors, they may also be set to operate as heavy-duty position servos. Numerous safety features are incorporated into the controller to ensure reliable and safe operation. A high efficiency version is also available for higher current operation in extended temperature environment.

The controller's operation can be extensively automated and customized using Basic Language scripts. The controller can be reprogrammed in the field with the latest features by downloading new operating software from Roboteq.

Applications

- Heavyweight, heavy duty robots
- Terrestrial and Underwater Robotic Vehicles
- Automatic Guided Vehicles
- Police and Military Robots
- Hazardous Material Handling Robots
- Telepresence Systems
- Animatronics
- Industrial Controls
- Hydraulic Pumps control

Key Features

- RS232, 0-5V Analog, or Pulse (RC radio) command modes
- Auto switch between RS232, Analog, or Pulse based on user-defined priority
- Built-in high-power power drivers for two brushed DC motors at up to 150A output per channel
- Full forward & reverse control on each channel. Four quadrant operation. Supports regeneration
- Operates from a single 10V-50V power source
- Programmable current limit for each channel up to 2x150A for protecting controller, motors, wiring and battery.
- Up to 4 Analog Inputs for use as command and/or feedback
- Up to 5 Pulse Length, Duty Cycle or Frequency Inputs for use as command and/or feedback
- Up to 6 Digital Inputs for use as Deadman Switch, Limit Switch, Emergency stop or user inputs
- Custom scripting in Basic language. Execution speed 50,000+ lines per second
- Two general purpose 24V, 1.0A output for brake release or accessories
- Selectable min, max, center and deadband in Pulse and Analog modes
- Selectable exponentiation factors for each command inputs
- Trigger action if Analog or Pulse or Encoder capture (soft limit switches)
- Open loop or closed loop speed control operation
- Closed loop position control with analog or pulse/frequency feedback
- PID control loop with separate gains for each channel
- Optional Mixed control (sum and difference) for tank-like steering

- Configurable Data Logging of operating parameters on RS232 Output for telemetry or analysis
- Built-in Battery Voltage and Temperature sensors
- Optional 12V backup power input for powering safely the controller if the main motor batteries are discharged
- Power Control wire for turning On or Off the controller from external microcomputer or switch
- No consumption by output stage when motors stopped
- Regulated 5V output for powering RC radio, RF Modem or microcomputer
- Separate Programmable acceleration and deceleration for each motor
- Separate Programmable maximum forward and reverse power
- Ultra-efficient 1.5 mOhm ON resistance MOSFETs
- Orderable as single channel version up to 300A
- Stall detection and selectable triggered action if amps is outside user-selected range
- Short circuit protection with selectable sensitivity levels
- 10 to 32kHz user programmable Pulse Width Modulation (PWM) output.
- Overvoltage and Undervoltage protection
- Watchdog for automatic motor shutdown in case of command loss
- Overtemperature protection
- Diagnostic LED
- Extruded aluminum, heat sinking enclosure for operation harsh shock and temperature environment
- Efficient heat sinking. Operates without a fan in most applications.
- Dustproof and weather resistant. IP51 NEMA rating
- Power wiring via heavy AWG8 cables
- 9" (228.5mm) L, 5.5" W (140mm), 1.6" (40mm) H
- -40o to +85o C operating environment
- 3 lbs (1,350g)
- Easy configuration, tuning and monitory using provided PC utility
- Field upgradeable software for installing latest features via the internet

Orderable Product References

Reference	Number of Channels	Amps/Channel	Volts
VDC2450	2	150A	50V
VDC2450S	1	300A	50V

Power Wires Identifications and Connection

Power connections are made by means of heavy gauge wires located at the back of the controller.

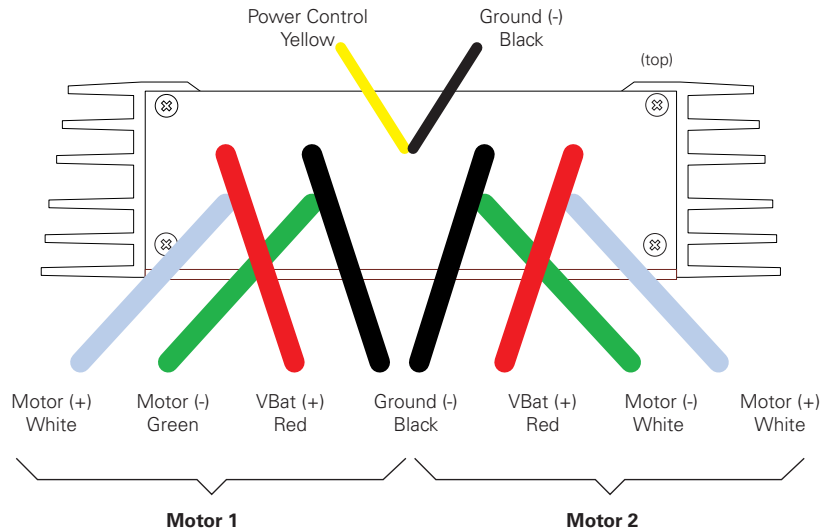

FIGURE 8. Rear Controller Layout

The diagram below shows how to wire the controller and how to turn power On and Off.

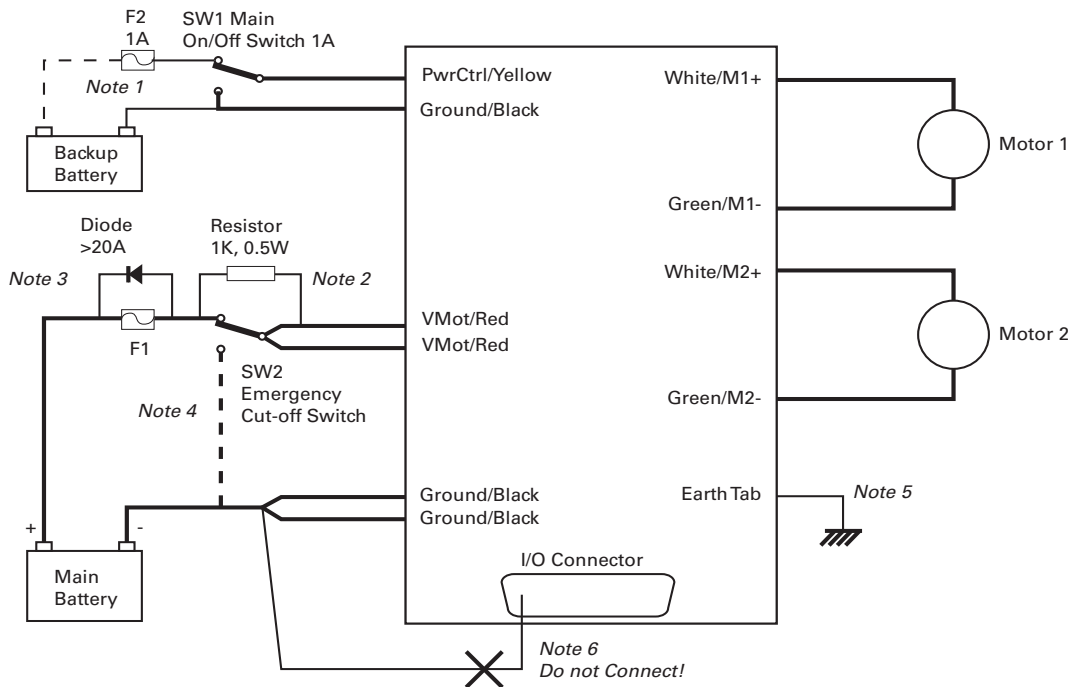

FIGURE 9. Powering the controller. Thick lines identify **MANDATORY** connections

Important Warning

Carefully follow the wiring instructions provided in the Read Me First sheet that comes with the controller, or in the Power Connection section of the User Manual. The information on this datasheet is only a summary.

Mandatory Connections

It is imperative that the controller is connected as shown in the above diagram in order to ensure a safe and trouble-free operation. All connections shown as thick black lines are mandatory. The controller must be powered On/Off using switch SW1 on the Yellow wire. Use a suitable high-current fuse F1 as a safety measure to prevent damage to the wiring in case of major controller malfunction.

The battery must be connected in permanence to the controller's Red wires via a high-power emergency switch SW2 as additional safety measure.

Precautions and Optional Connections

Note1: Backup battery to ensure motor operation with weak or discharged batteries, connect a second battery to the Power Control wire/terminal via the SW1 switch.

Note2: Use precharge 1K, 0.5W Resistor to prevent switch arcing.

Note3: Insert a high-current diode to ensure a return path to the battery during regeneration in case the fuse is blown.

Note4: Optionally ground the VBat wires when the controller is Off if there is any concern that the motors could be made to spin and generate voltage in excess of 50V.

Note5: Connect the controller's earth tab to a wire connected to the Earth while the charger is plugged in the AC main, or if the controller is powered by an AC power supply.

Note6: Beware not to create a path from the ground pins on the I/O connector and the battery's minus terminal.

Sensor and Commands Connection

Connection to RC Radio, Microcomputer, Joystick and other low current sensors and actuators is done via the 15-pin connector located in front of the controller. The functions of many pins vary depending on controller model and user configuration. Pin assignment is found in the table below.

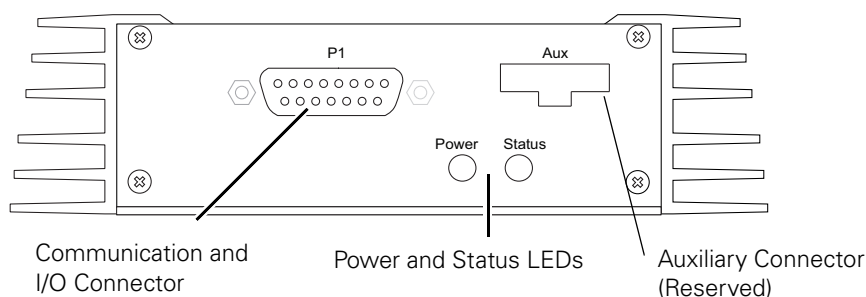

FIGURE 10. Front Controller Layout

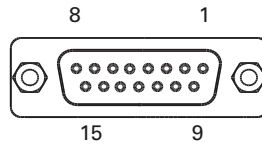

FIGURE 11. Connector pin locations

TABLE 4.

Connector Pin	Power	Dout	Com	RC	Ana	Dinput	Default Config
1		DOUT1					Unused
9		DOUT2					Unused
2			TxOut				RS232Tx
10				RC5	ANA1	DIN5	AnaCmd1
3			RxIn				RS232Rx
11				RC4	ANA4	DIN4	AnaCmd2
4				RC1		DIN1	RCRadio1
12				RC3	ANA3	DIN3	Unused
5	GND						
13	GND						
6			SCLI				Reserved
14	5VOut						
7			SDAI				Reserved
15						DIN6	Unused
8				RC2	ANA2	DIN2	RCRadio2

Default I/O Configuration

The controller can be configured so that practically any Digital, Analog and RC pin can be used for any purpose. The controller's factory default configuration provides an assignment that is suitable for most applications. The figure below shows how to wire the controller to two analog potentiometers, an RC radio, and the RS232 port. It also shows how to connect the two outputs to motor brake solenoids. You may omit any connection that is not required in your application. The controller automatically arbitrates the command priorities depending on the presence of a valid command signal in the following order: 1-RS232, 2-RC Pulse, 3-Analog. If needed, use the Robo-run+ PC Utility to change the pin assignments and the command priority order.

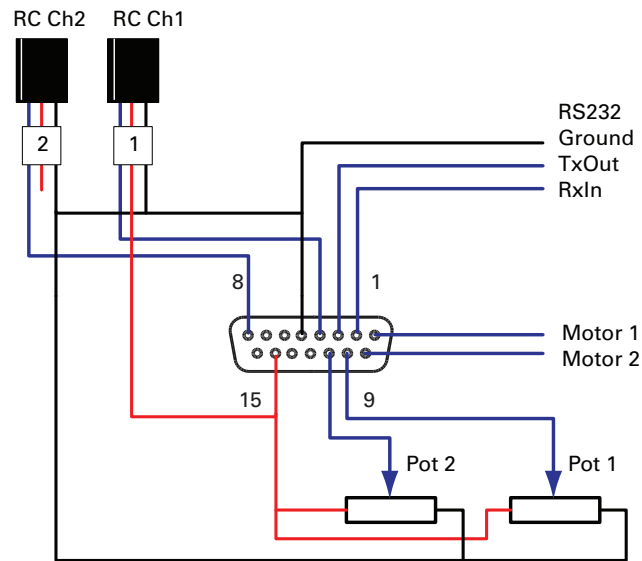

FIGURE 12. Factory default pins assignment

Status LED Flashing Patterns

After the controller is powered on, the Power LED will turn on, indicating that the controller is On. The Status LED will be flashing at a 2 seconds interval. The flashing pattern provides operating or exception status information.

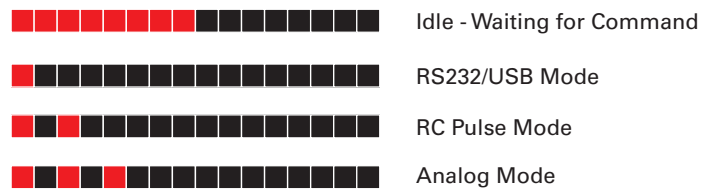

FIGURE 13. Normal Operation Flashing Patterns

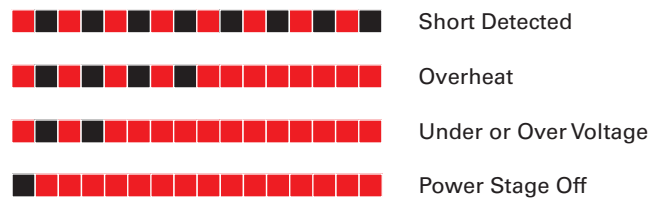

FIGURE 14. Exception or Fault Flashing Patterns

Additional status information may be obtained by monitoring the controller with the PC utility.

Electrical Specifications

Absolute Maximum Values

The values in the table below should never be exceeded, Permanent damage to the controller may result.

TABLE 5.

Parameter	Measure point	Min	Typ	Max	Units
Battery Leads Voltage	Ground to VBat			55	Volts
Reverse Voltage on Battery Leads	Ground to VBat	-1			Volts
Power Control Voltage	Ground to Pwr Control wire			65	Volts
Motor Leads Voltage	Ground to M1+, M1-, M2+, M2-			55 (1)	Volts
Digital Output Voltage	Ground to Output pins			30	Volts
Analog and Digital Inputs Voltage	Ground to any signal pin on 15-pin connectors			15	Volts
RS232 I/O pins Voltage	External voltage applied to Rx/Tx pins			15	Volts
Case Temperature	Case	-40		85	oC
Humidity	Case			100 (2)	%

Note 1: Maximum regeneration voltage in normal operation. Never inject a DC voltage from a battery or other fixed source
 Note 2: Non-condensing

Power Stage Electrical Specifications (at 25oC ambient)

TABLE 6.

Parameter	Measure point	Models	Min	Typ	Max	Units
Battery Leads Voltage	Ground to VBat	All	0 (1)		55	Volts
Motor Leads Voltage	Ground to M1+, M1-, M2+, M2-	All	0 (1)		55 (2)	Volts
Power Control Voltage	Ground to Power Control wire	All	0 (1)		65	Volts
Minimum Operating Voltage	VBat or Pwr Ctrl wires	All	9 (3)			Volts
Over Voltage protection range	Ground to VBat	All	5	50 (4)	55	Volts
Under Voltage protection range	Ground to VBat	All	0	5 (4)	55	Volts
Idle Current Consumption	VBat or Pwr Ctrl wires	All	50	100 (5)	150	mA
ON Resistance (Excluding wire resistance)	VBat to M+, plus M- to Ground at 100% power. Per channel	VDC2450		3		mOhm
		VDC2450S		1.5		mOhm
Max Current per channel for 30s	Ch1 or Ch2 Motor current	VDC2450			150	Amps
		VDC2450S			300 (6)	Amps
Continuous Max Current per channel	Ch1 or Ch2 Motor current	VDC2450			80 (7)	Amps
		VDC2450S			160 (6)(7)	Amps
Current Limit range	Ch1 or Ch2 Motor current	VDC2450	10	100 (8)	150	Amps
		VDC2450S	10	200 (8)	300 (6)	Amps
Stall Detection Amps range	Ch1 or Ch2 Motor current	VDC2450	10	100 (8)	150	Amps
		VDC2450S	10	200 (8)	300 (6)	Amps

TABLE 6.

Parameter	Measure point	Models	Min	Typ	Max	Units
Stall Detection timeout range	Ch1 or Ch2 Motor current	All	1	65000 (9)	65000	milli-seconds
Short Circuit Detection threshold (10)	Between Motor wires or Between Motor wire and Ground	VDC2450	550		1600	Amps
		VDC2450S	1100		3000 (6)	Amps
Short Circuit Detection threshold	Between Motor wires and VBat	All	No Protection. Permanent damage will result			
Motor Acceleration/Deceleration range	Ch1 or Ch2	All	100	500 (11)	65000	milli-seconds

Note 1: Negative voltage will cause a large surge current. Protection fuse needed if battery polarity inversion is possible
 Note 2: Maximum regeneration voltage in normal operation. Never inject a DC voltage from a battery or other fixed source
 Note 3: Minimum voltage must be present on VBat or Power Control wire
 Note 4: Factory default value. Adjustable in 0.1V increments
 Note 5: Current consumption is lower when higher voltage is applied to the controller's VBat or PwrCtrl wires
 Note 6: Current is sum of both synchronized channels. Current must be balanced between channel to obtain max current.
 Note 7: Estimate. Limited by case temperature. Current may be higher with better cooling
 Note 8: Factory default value. Adjustable in 0.1A increments
 Note 9: Factory default value. Time in ms that Stall current must be exceeded for detection
 Note 10: Controller will stop until restarted in case of short circuit detection
 Note 11: Factory default value. Time in ms for power to go from 0 to 100%

Command, I/O and Sensor Signals Specifications

TABLE 7.

Parameter	Measure point	Min	Typ	Max	Units
Main 5V Output Voltage	Ground to 5V pins on	4.6	4.75	4.9	Volts
5V Output Current	5V pins on RJ45 and DSub15			200 (1)	mA
Digital Output Voltage	Ground to Output pins			30	Volts
Output On resistance	Output pin to ground		0.25	0.5	Ohm
Output Short circuit threshold	Output pin	1.7		3.5	Amps
Digital Output Current	Output pins, sink current		1.0	1.5	Amps
Input Impedances (except DIN11-19)	AIN/DIN Input to Ground		53		kOhm
Digital Input 0 Level	Ground to Input pins	-1		1	Volts
Digital Input 1 Level	Ground to Input pins	3		15	Volts
Analog Input Range	Ground to Input pins	0		5.1	Volts
Analog Input Precision	Ground to Input pins		0.5		%
Analog Input Resolution	Ground to Input pins		1		mV
Pulse durations	Pulse inputs	20000		10	us
Pulse repeat rate	Pulse inputs	50		250	Hz
Pulse Capture Resolution	Pulse inputs		1		us
Frequency Capture	Pulse inputs	100		10000	Hz

Note 1: Sum of all 5VOut outputs

Operating & Timing Specifications

TABLE 8.

Parameter	Measure Point	Min	Typ	Max	Units
Command Latency	Command to output change	1	0.5	1	ms
PWM Frequency	Ch1, Ch2 outputs	10	18	32	kHz
Closed Loop update rate	Internal		1000		Hz
RS232 baud rate	Rx & Tx pins		115200 (1)		Bits/s
RS232 Watchdog timeout	Rx pin	1 (2)		65000	ms
Note 1: 115200, 8-bit, no parity, 1 stop bit, no flow control					
Note 2: May be disabled with value 0					

Scripting

TABLE 9.

Parameter	Measure Point	Min	Typ	Max	Units
Scripting Flash Memory	Internal		8192		Bytes
Max Basic Language programs	Internal	1000		1500	Lines
Integer Variables	Internal		1024		Words (1)
Boolean Variables	Internal		1024		Symbols
Execution Speed	Internal	50 000	100 000		Lines/s
Note 1: 32-bit words					

Thermal Specifications

TABLE 10.

Parameter	Measure Point	Min	Typ	Max	Units
Case Temperature	Case	-40		85 (1)	oC
Thermal Protection range	Case	80		90 (2)	oC
Power Dissipation	Case			70	Watts
Thermal resistance	Power MOSFETs to case			0.6	oC/W
Note 1: Thermal protection will protect the controller power					
Note 2: Max allowed power out starts lowering at minimum of range, down to 0 at max of range					

Mechanical Specifications

TABLE 11.

Parameter	Measure Point	Min	Typ	Max	Units
Weight	Case		1.0 (2.0)		kg (lbs)
Wire Length	Case		17 (43)		inches (mm)
Power Wire Gauge	Wire		8		AWG
Power Wire Diameter	Outside diameter		0.26 (6.6)		inches (mm)

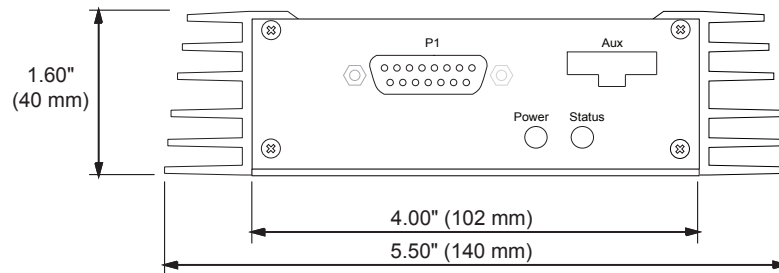

FIGURE 15. VDC2450 front view and dimensions

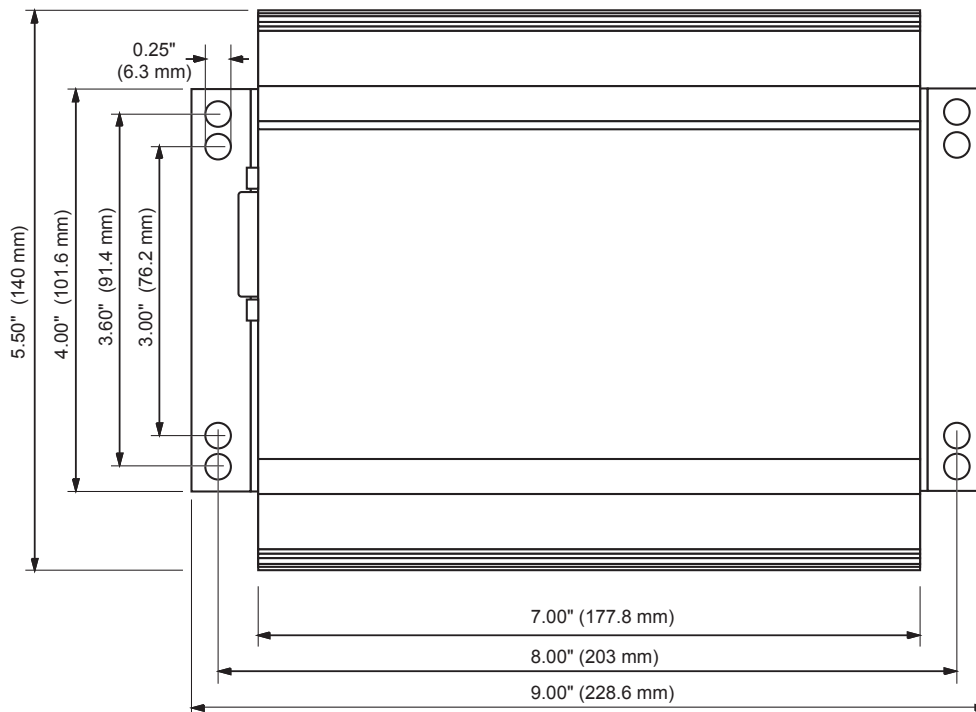

FIGURE 16. VDC2450 top view and dimensions