

2 x 75A Dual Channel Brushless DC Motor Controller



Roboteq's VBL2350 is a high-current, dual channel controller for hall-sensor equipped Brushless DC motors. The controller uses the position information from the sensors to sequence power on the motors' 3 windings in order to generate smooth continuous rotation. The controller also uses the Hall sensor information to compute speed and measure travelled distance inside a 32-bit counter. The motors may be operated in open or closed loop speed mode. Using low-cost position sensors, they may also be set to operate as heavy-duty position servos.

The VBL2350 accepts commands received from an RC radio, Analog Joystick, wireless modem, or microcomputer. For mobile robot applications, the controller's two motor channels can either be operated independently or mixed to set the direction and rotation of a vehicle by coordinating the motion of each motor.

Numerous safety features are incorporated into the controller to ensure reliable and safe operation. The controller's operation can be extensively automated and customized using Basic Language scripts. The controller can be configured, monitored and tuned in realtime using a Roboteq's free PC utility. The controller can also be reprogrammed in the field with the latest features by downloading new operating software from Roboteq.

Applications

- Small Electric Vehicles, Electric Bikes
- Terrestrial and Underwater Robotic Vehicles
- Automatic Guided Vehicles
- Police and Military Robots
- Hazardous Material Handling Robots
- Balancing Robots
- Telepresence Systems
- Animatronics
- Industrial Controls

Key Features

- RS232, 0-5V Analog, or Pulse (RC radio) command modes
- Auto switch between RS232, Analog, or Pulse based on user-defined priority
- Built-in dual 3-phase high-power drivers for two brushless DC motor at up to 75A
- Trapezoindal switching based on Hall Sensor position information.
- Full forward & reverse motor control. Four quadrant operation. Supports regeneration
- Operates from a single 10V-50V power source
- Programmable current limit up to 75A for protecting controller, motor, wiring and battery.
- Connector for Hall Sensors
- Accurate speed and Odometry measurement using Hall Sensor data
- Up to 4 Analog Inputs for use as command and/or feedback
- Up to 5 Pulse Length, Duty Cycle or Frequency Inputs for use as command and/or feedback
- Up to 6 Digital Inputs for use as Deadman Switch, Limit Switch, Emergency stop or user inputs
- Two general purpose 24V, 1.5A output for brake release or accessories
- Selectable min, max, center and deadband in Pulse and Analog modes
- Selectable exponentiation factors for each command inputs
- Trigger action if Analog, Pulse or Hall counter capture are outside user selectable range (soft limit switches)
- Open loop or closed loop speed control operation
- Closed loop position control with encoder, analog or pulse/frequency feedback

- PID control loop
- Configurable Data Logging of operating parameters on RS232 Output for telemetry or analysis
- Built-in Battery Voltage and Temperature sensors
- Optional 12V backup power input for powering safely the controller if the main motor batteries are discharged
- Power Control wire for turning On or Off the controller from external microcomputer or switch
- No consumption by output stage when motors stopped
- Regulated 5V output for powering RC radio, RF Modem or microcomputer
- Separate Programmable acceleration and deceleration for each motor
- Ultra-efficient 3 mOhm ON resistance MOSFETs
- Auto stop if no motion is detected
- Stall detection and selectable triggered action if Amps is outside user-selected range
- Short circuit protection with selectable sensitivity levels
- 10 to 32kHz user programmable Pulse Width Modulation (PWM) output.
- Overvoltage and Undervoltage protection
- Watchdog for automatic motor shutdown in case of command loss
- Overtemperature protection
- Diagnostic LED
- Extruded aluminum, heat sinking enclosure for operation harsh shock and temperature environment
- Efficient heat sinking. Operates without a fan in most applications.
- Dustproof and weather resistant. IP51 NEMA rating
- Power wiring via heavy AWG8 battery cables and AWG10 motor cables
- 9" (228.5mm) L, 5.5" W (140mm), 1.6" (40mm) H
- -40o to +85o C operating environment
- 3 lbs (1,350g)
- Easy configuration, tuning and monitory using provided PC utility
- Field upgradeable software for installing latest features via the internet

Orderable Product References

Reference	Number of Channels	Amps/Channel	Volts
VBL2350	2	75	50V

Power Wires Identifications and Connection

Power connections are made by means of heavy gauge wires located at the back of the controller.

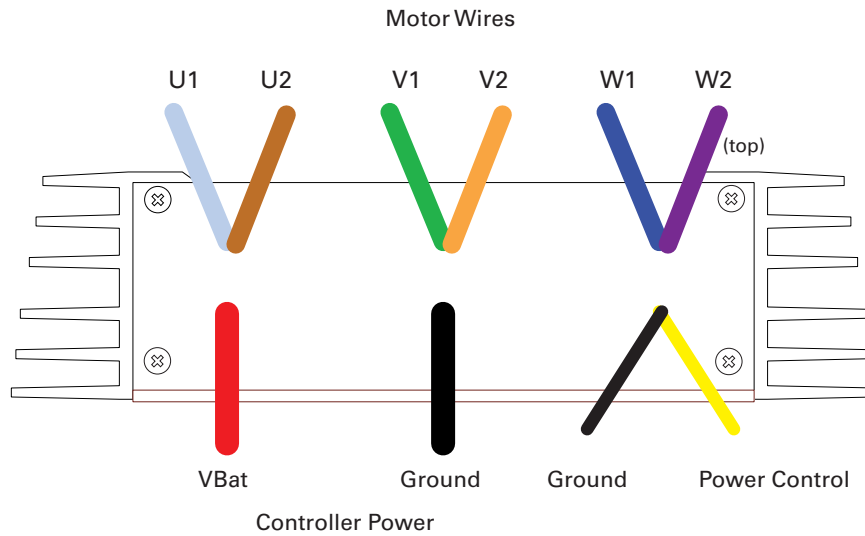

FIGURE 8. Rear Controller Layout

The diagram below shows how to wire the controller and how to turn power On and Off.

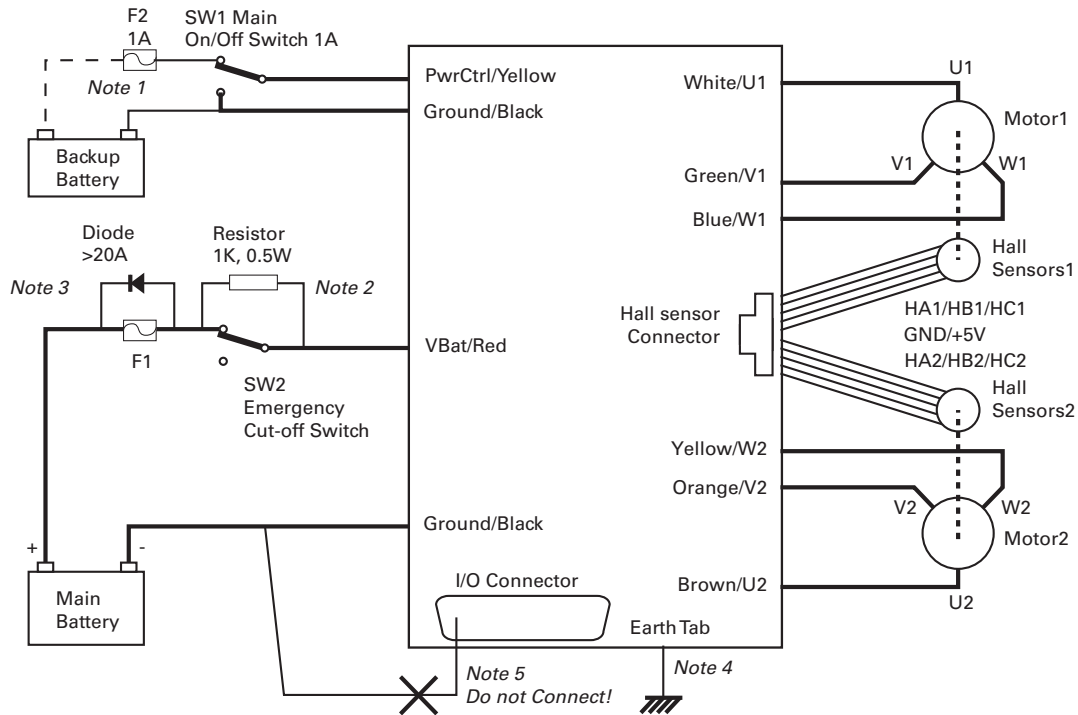

FIGURE 9. Powering the controller. Thick lines identify **MANDATORY** connections

Important Warning

Carefully follow the wiring instructions provided in the Read Me First sheet that comes with the controller, or in the Power Connection section of the User Manual. The information on this datasheet is only a summary.

Mandatory Connections

It is imperative that the controller is connected as shown in the above diagram in order to ensure a safe and trouble-free operation. All connections shown as thick black lines are mandatory. The controller must be powered On/Off using switch SW1 on the Yellow wire. Use a suitable high-current fuse F1 as a safety measure to prevent damage to the wiring in case of major controller malfunction.

The battery must be connected in permanence to the controller's Red wires via a high-power emergency switch SW2 as additional safety measure.

Precautions and Optional Connections

Note1: Backup battery to ensure motor operation with weak or discharged batteries, connect a second battery to the Power Control wire/terminal via the SW1 switch.

Note2: Use precharge 1K, 0.5W Resistor to prevent switch arcing.

Note3: Insert a high-current diode to ensure a return path to the battery during regeneration in case the fuse is blown.

Note4: Optionally ground the VBat wires when the controller is Off if there is any concern that the motors could be made to spin and generate voltage in excess of 50V.

Note5: Connect the controller's earth tab to a wire connected to the Earth while the charger is plugged in the AC main, or if the controller is powered by an AC power supply.

Note6: Beware not to create a path from the ground pins on the I/O connector and the battery minus terminal.

Hall Sensors Connection

Connection to the Hall Sensors is done using a special connector on the front side of the controller. The figure below shows the location of the various low-voltage connectors and LEDs on the controller.

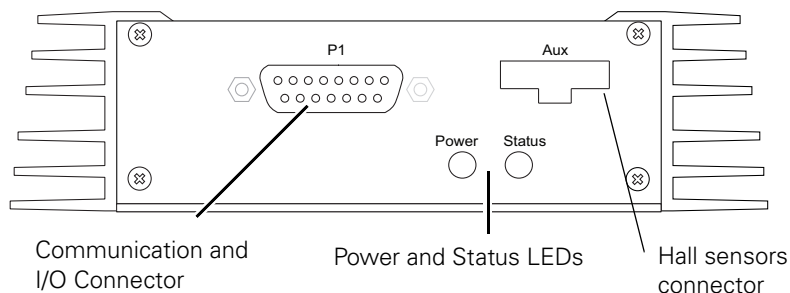

FIGURE 10. Front Controller Layout

The Hall sensor connector is a 10-pin Molex Microfit 3.0, ref. 43025-1000. Pin assignment is in the table below.

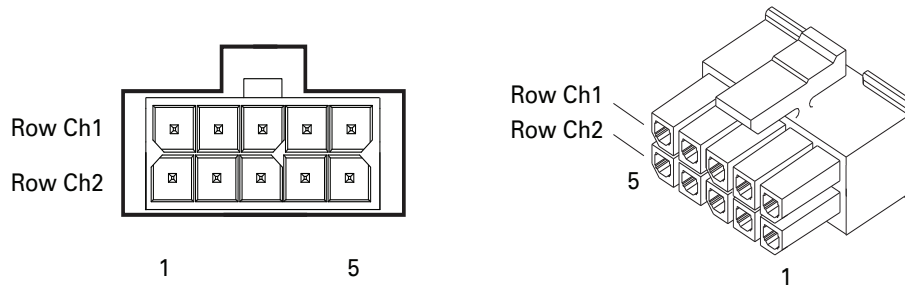

FIGURE 11. Hall Sensors connector

TABLE 4.

Pin Number	1	2	3	4	5
Row Ch1	5V	Hall1 C	Hall1 B	Hall1 A	Ground
Row Ch2	5V	Hall2 C	Hall2 B	Hall2 A	Ground

Hall Sensor vs Motor Output sequencing

The controller requires the Hall sensors inside the motor to be 120 degrees apart. The controller’s 3-phase bridge will activate each of the motor winding according to the sequence shown in the figure below.

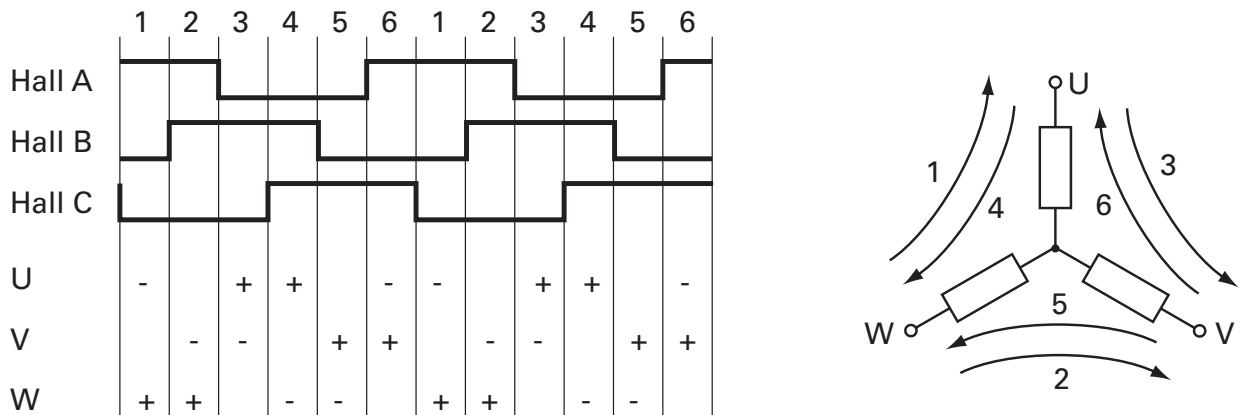

FIGURE 12. Hall Sensors sequence

Commands and I/O Connections

Connection to RC Radio, Microcomputer, Joystick and other low current sensors and actuators is done via the 15-pin connector located in front of the controller. The functions of many pins vary depending on controller model and user configuration. Pin assignment is found in the table below.

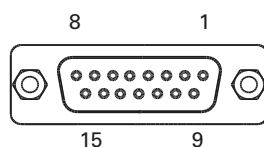

FIGURE 13. Connector pin locations

TABLE 5.

Connector Pin	Power	Dout	Com	RC	Ana	Dinput	Default Config
1		DOUT1					Unused
9		DOUT2					Unused
2			TxOut				RS232Tx
10				RC5	ANA1	DIN5	AnaCmd1
3			RxIn				RS232Rx
11				RC4	ANA4	DIN4	AnaCmd2
4				RC1		DIN1	RCRadio1
12				RC3	ANA3	DIN3	Unused
5	GND						
13	GND						
6			SCLI				Reserved
14	5VOut						
7			SDAI				Reserved
15						DIN6	Unused
8				RC2	ANA2	DIN2	RCRadio2

Default I/O Configuration

The controller can be configured so that practically any Digital, Analog and RC pin can be used for any purpose. The controller's factory default configuration provides an assignment that is suitable for most applications. The figure below shows how to wire the controller to two analog potentiometers, an RC radio, and the RS232 port. It also shows how to connect the two outputs to motor brake solenoids. You may omit any connection that is not required in your application. The controller automatically arbitrates the command priorities depending on the presence of a valid command signal in the following order: 1-RS232, 2-RC Pulse, 3-Analog. If needed, use the Robo-run+ PC Utility to change the pin assignments and the command priority order.

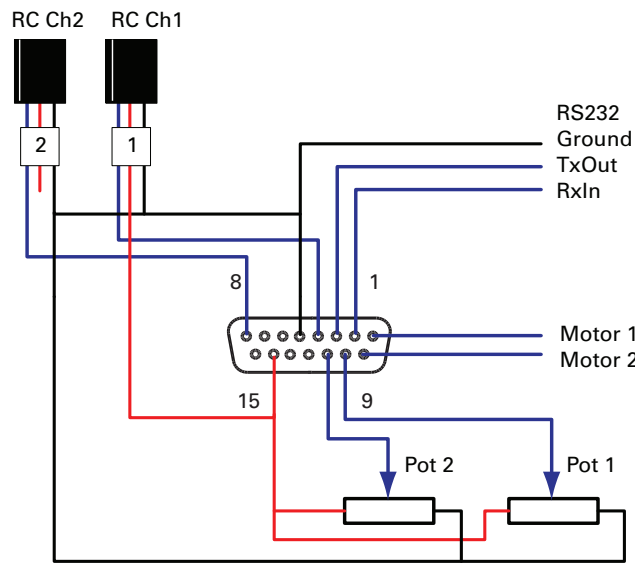

FIGURE 14. Factory default pins assignment

Status LED Flashing Patterns

After the controller is powered on, the Power LED will turn on, indicating that the controller is On. The Status LED will be flashing at a 2 seconds interval. The flashing pattern provides operating or exception status information.

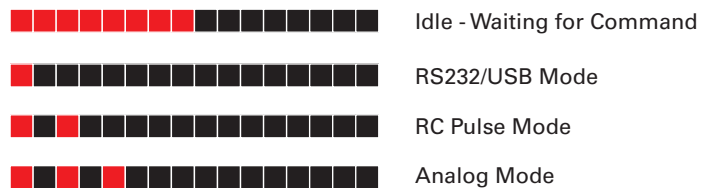

FIGURE 15. Normal Operation Flashing Patterns

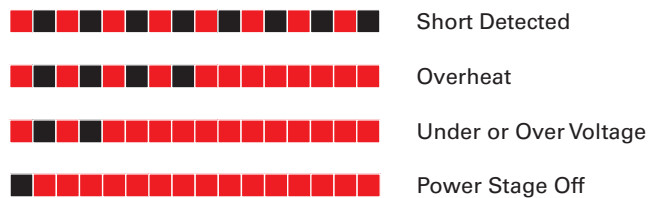

FIGURE 16. Exception or Fault Flashing Patterns

Additional status information may be obtained by monitoring the controller with the PC utility.

Electrical Specifications

Absolute Maximum Values

The values in the table below should never be exceeded, Permanent damage to the controller may result.

TABLE 6.

Parameter	Measure point	Min	Typ	Max	Units
Battery Leads Voltage	Ground to VBat			55	Volts
Reverse Voltage on Battery Leads	Ground to VBat	-1			Volts
Power Control Voltage	Ground to Pwr Control wire			65	Volts
Motor Leads Voltage	Ground to U, V, W wires			55 (1)	Volts
Digital Output Voltage	Ground to Output pins			30	Volts
Analog and Digital Inputs Voltage	Ground to any signal pin on 15-pin & Hall inputs			15	Volts
RS232 I/O pins Voltage	External voltage applied to Rx/Tx pins			15	Volts
Case Temperature	Case	-40		85	oC
Humidity	Case			100 (2)	%

Note 1: Maximum regeneration voltage in normal operation. Never inject a DC voltage from a battery or other fixed source
 Note 2: Non-condensing

Power Stage Electrical Specifications (at 25oC ambient)

TABLE 7.

Continuous Max Current per channel	Measure point	Min	Typ	Max	Units
Battery Leads Voltage	Ground to VBat	0 (1)		50	Volts
Motor Leads Voltage	Ground to U, V, W wires	0 (1)		50 (2)	Volts
Power Control Voltage	Ground to Power Control wire	0 (1)		65	Volts
Minimum Operating Voltage	VBat or Pwr Ctrl wires	9 (3)			Volts
Over Voltage protection range	Ground to VBat	5	50 (4)	55	Volts
Under Voltage protection range	Ground to VBat	0	5 (4)	55	Volts
Idle Current Consumption	VBat or Pwr Ctrl wires	50	100 (5)	150	mA
ON Resistance (Excluding wire resistance)	VBat to U, V or W. Ground to U, V or W		3		mOhm
Max Current for 30s	Motor current			75	Amps
Continuous Max Current per channel	Motor current			40(6)	Amps
Current Limit range	Motor current	10	50 (7)	75	Amps
Stall Detection Amps range	Motor current	10	75 (7)	75	Amps
Stall Detection timeout range	Motor current	1	500 (8)	65000	milliseconds
Short Circuit Detection threshold (9)	Between Motor wires or Between Motor wires and Ground	140 (10)		400 (10)	Amps
Short Circuit Detection threshold	Between Motor wires and VBat	No Protection. Permanent damage will result			

TABLE 7.

Continuous Max Current per channel	Measure point	Min	Typ	Max	Units
Motor Acceleration/Deceleration range	Motor Output	100	500 (11)	65000	milliseconds
Note 1: Negative voltage will cause a large surge current. Protection fuse needed if battery polarity inversion is possible Note 2: Maximum regeneration voltage in normal operation. Never inject a DC voltage from a battery or other fixed source Note 3: Minimum voltage must be present on VBat or Power Control wire Note 4: Factory default value. Adjustable in 0.1V increments Note 5: Current consumption is lower when higher voltage is applied to the controller's VBat or PwrCtrl wires Note 6: Estimate. Limited by case temperature. Current may be higher with better cooling Note 7: Factory default value. Adjustable in 0.1A increments Note 8: Factory default value. Time in ms that Stall current must be exceeded for detection Note 9: Controller will stop until restarted in case of short circuit detection Note 10: Sensitivity selectable by software Note 11: Factory default value. Time in ms for power to go from 0 to 100%					

Command, I/O and Sensor Signals Specifications

TABLE 8.

Parameter	Measure point	Min	Typ	Max	Units
Main 5V Output Voltage	Ground to 5V pins on	4,6	4,75	4,9	Volts
5V Output Current	5V pins on RJ45 and DSub15			200 (1)	mA
Digital Output Voltage	Ground to Output pins			30	Volts
Output On resistance	Output pin to ground		0,25	0,5	Ohm
Output Short circuit threshold	Output pin	1,7		3,5	Amps
Digital Output Current	Output pins, sink current			1,5	Amps
Input Impedances (except DIN11-19)	AIN/DIN Input to Ground		53		kOhm
Digital Input 0 Level	Ground to Input pins	-1		1	Volts
Digital Input 1 Level	Ground to Input pins	3		15	Volts
Analog Input Range	Ground to Input pins	0		5,1	Volts
Analog Input Precision	Ground to Input pins		0,5		%
Analog Input Resolution	Ground to Input pins		1		mV
Pulse durations	Pulse inputs	20000		10	us
Pulse repeat rate	Pulse inputs	50		250	Hz
Pulse Capture Resolution	Pulse inputs		1		us
Frequency Capture	Pulse inputs	100		10000	Hz
Note 1: Sum of all 5VOut outputs					

Operating & Timing Specifications

TABLE 9.

Parameter	Measure Point	Min	Typ	Max	Units
Command Latency	Command to output change	1	0,5	1	ms
PWM Frequency	Motor Output	10	18	32	kHz
Closed Loop update rate	Internal		1000		Hz
RS232 baud rate	Rx & Tx pins		115200 (1)		Bits/s
RS232 Watchdog timeout	Rx pin	1 (2)		65000	ms
Note 1: 115200, 8-bit, no parity, 1 stop bit, no flow control					
Note 2: May be disabled with value 0					

Scripting

TABLE 10.

Parameter	Measure Point	Min	Typ	Max	Units
Scripting Flash Memory	Internal		8192		Bytes
Max Basic Language programs	Internal	1000		1500	Lines
Integer Variables	Internal		1024		Words (1)
Boolean Variables	Internal		1024		Symbols
Execution Speed	Internal	50 000	100 000		Lines/s
Note 1: 32-bit words					

Thermal Specifications

TABLE 11.

Parameter	Measure Point	Min	Typ	Max	Units
Case Temperature	Case	-40		85 (1)	oC
Thermal Protection range	Case	80		90 (2)	oC
Power Dissipation	Case			70	Watts
Thermal resistance	Power MOSFETs to case			0,6	oC/W
Humidity	Case			100(3)	%
Note 1: Thermal protection will protect the controller power					
Note 2: Max allowed power out starts lowering at minimum of range, down to 0 at max of range					

Mechanical Specifications

TABLE 12.

Parameter	Measure Point	Min	Typ	Max	Units
Weight	Case		1.0 (2.0)		kg (lbs)
Wire Length	Case		17 (43)		inches (mm)

TABLE 12.

Parameter	Measure Point	Min	Typ	Max	Units
Battery Wire Gauge	Wire		8		AWG
Battery Wire Diameter	Outside diameter		0.26 (6.6)		inches (mm)
Motor Wire Gauge	Wire		8		AWG
Motor Wire Diameter	Outside diameter		0.26 (6.6)		inches (mm)

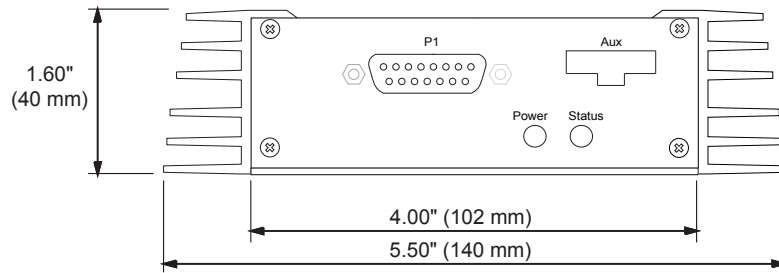

FIGURE 17. VBL2350 front view and dimensions

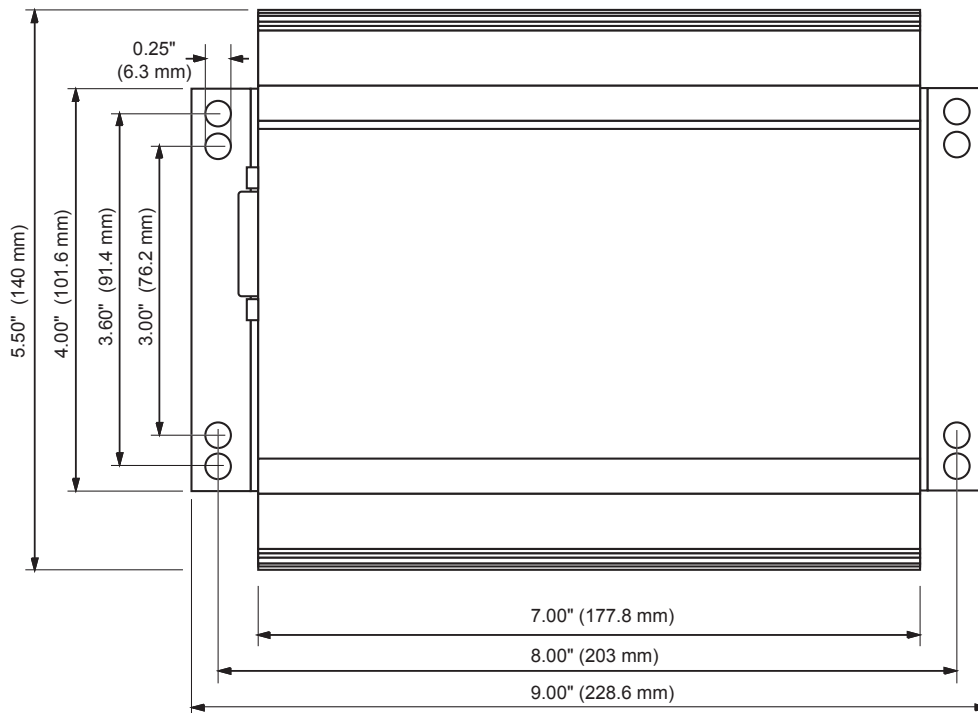

FIGURE 18. VBL2350 top view and dimensions

